

# 일정 관리 DWS

Team 1

201811169 김재현, 201611261 민지호  
201611276 이규은, 201811301 한지희

2041

Real Use Cases

2042

Reports, UI, Storyboards

2043

Interaction Diagrams

2044

Design Class Diagrams

2047

Traceability Analysis

*Index*

---

**2041** 

---

- Real Use Cases

**2042** 

---

- Reports, UI, and Storyboards

**2043** 

---

- Interaction Diagrams

**2044** 

---

- Design Class Diagram

**2047** 

---

- 2040 Traceability Analysis



## 2041 Design Real Use Cases – Use Cases

Use Case	1. Get Listed Schedule
Actors	System
Type	Hidden
Pre-Requisites	1개 이상의 Schedule이 존재
Typical Courses of Events	(A) Actor, (S) System 1. (S) Schedule 모드에서 Schedule 리스트 화면(Schedule Window-1)에 Schedule 정렬 기준(월/일/시/분/타입)에 따라 오름차순으로 정렬 2. (S) 정렬 기준 값이 같은 경우, 일정의 등록 혹은 수정 순서대로 정렬 3. (S) 정렬 후, 현재 시간 이전의 Schedule이 존재한다면 삭제
Alternative Courses of Events	N/A
Exceptional Courses of Events	N/A

## 2041 Design Real Use Cases – Use Cases

Use Case	2. Add Schedule
Actors	User
Type	Evident
Pre-Requisites	현재 모드가 Schedule 모드
Typical Courses of Events	<p>(A) Actor, (S) System</p> <ol style="list-style-type: none"> <li>(A) Schedule 모드(Schedule Window-1)에서 버튼 B를 3초 이상 누름</li> <li>(S) Schedule 초기 값을 불러와 설정 화면(Schedule Window-2)으로 전환</li> <li>(A) Schedule 입력 값을 버튼 A(증가), 버튼 C(감소)로 설정(최댓값에서 A를 누르면 최솟값으로, 최솟값에서 C를 누르면 최댓값으로 변경)</li> <li>(A) 버튼 D를 눌러 단위 변경(타입-&gt;시-&gt;분-&gt;월-&gt;일)</li> <li>(A) 3-4번을 반복하여 Schedule 정보를 입력</li> <li>(S) 현재 시간보다 이전 시간이 입력되면 Schedule 추가가 완료되지 않고, 설정 화면(window-2) 계속 유지(5번 단계 유지)</li> <li>(A) 버튼 B를 입력하여 Schedule 추가 완료</li> <li>(S) 새로운 Schedule 생성</li> <li>(S) Schedule 설정 화면(Schedule Window-2)가 종료되어 Schedule 모드(Schedule Window-1)로 전환</li> </ol>
Alternative Courses of Events	<p>A3-1. 최댓값은 월=12, 일=해당 달에 맞는 일수, 시=23, 분=59  A3-2. 최솟값은 월=1, 일=1, 시=0, 분=0  A3-3. 월이 바뀌어 일수의 최댓값이 더 큰 달에서 작은 달로 바뀐다면, 해당 일수는 최솟값(1)으로 바뀜  ex) 1월 31일에서 월을 2월로 바꾼다면, 자동적으로 2월 1일로 변환  A3-4. 각 단위의 값은 다른 단위 값에 영향을 주지 않음  ex) 11시 59분에서 1분을 증가시키면 12시가 아닌 11시 00분으로 변환  A7. Schedule 값이 입력되지 않은 채로 종료된 단위는 초기값(0시 0분 1월 1일)으로 저장</p>
Exceptional Courses of Events	N/A

## 2041 Design Real Use Cases – Use Cases

Use Case	3. Modify Schedule
Actors	User
Type	Evident
Pre-Requisites	현재 모드가 Schedule 모드, 1개 이상의 Schedule이 존재
Typical Courses of Events	<p>(A) Actor, (S) System</p> <ol style="list-style-type: none"> <li>(A) Schedule 모드(Schedule Window-1)에서 버튼 A(올라감), 버튼 C(내려감)을 통해, 커서를 이동</li> <li>(A) Schedule 모드(Schedule Window-1)에서 커서가 원하는 Schedule일 때, 버튼B를 누름</li> <li>(S) Schedule의 기존 값을 불러와 설정 화면(Schedule Window-3)으로 전환</li> <li>(A) Schedule 입력 값을 버튼 A(증가), 버튼 C(감소)로 설정(최댓값에서 A를 누르면 최솟값으로, 최솟값에서 C를 누르면 최댓값으로 변경)</li> <li>(A) 버튼D를 눌러서 단위를 변경(타임-&gt;시-&gt;분-&gt;월-&gt;일)</li> <li>(A) 3-4번을 반복하여 Schedule 정보를 입력</li> <li>(S) 현재 시간보다 이전 시간이 입력되면 Schedule 수정이 완료 되지 않고, 설정 화면(Schedule window-3) 계속 유지(5번 유지)</li> <li>(A) 버튼 B 입력하여 Schedule 수정 완료</li> <li>(S) Schedule 정보 수정</li> <li>(S) Schedule 설정 화면(Schedule Window-2)가 종료되어 Schedule 모드(Schedule Window-1)로 전환</li> </ol>
Alternative Courses of Events	<p>A1. 마지막 Schedule에서 버튼 C를 누르거나, 첫번째 Schedule에서 버튼 A를 누르면 반응하지 않음  A3-1. 최댓값은 월=12, 일=해당 달에 맞는 일수, 시=23, 분=59 / A3-2. 최솟값은 월=1, 일=1, 시=0, 분=0  A3-3. 월이 바뀌어 일수의 최댓값이 더 큰 달에서 작은 달로 바뀐다면, 해당 일수는 최솟값(1)로 바뀜  ex) 1월 31일에서 월을 2월로 바꾼다면, 자동적으로 2월 1일로 변환된다.  A3-4. 각 단위의 값은 다른 단위 값에 영향을 주지 않음 ex) 11시 59분에서 1분을 증가시키면 12시가 아닌 11시 00분이 됨  A7. Schedule 값이 입력되지 않은 채로 종료된 단위는 초기값(0시 0분 1월 1일)으로 저장</p>
Exceptional Courses of Events	N/A

## 2041 Design Real Use Cases – Use Cases

Use Case	4. Delete Schedule
Actors	User
Type	Evident
Pre-Requisites	현재 모드가 Schedule 모드 1개 이상의 Schedule이 존재
Typical Courses of Events	(A) Actor, (S) System 1. (A) Schedule 모드(Schedule Window-1)에서 버튼 A(올라감), 버튼 C(내려감)을 통해, 커서를 이동 2. (A) Schedule 모드(Schedule Window-1)에서 커서가 원하는 Schedule일 때, 버튼C를 3초 이상 누름 3. (S) 선택된 Schedule을 삭제
Alternative Courses of Events	A1. 마지막 Schedule에서 버튼 C를 누르거나, 첫번째 Schedule에서 버튼 A를 누르면 반응하지 않음
Exceptional Courses of Events	N/A

## 2041 Design Real Use Cases – Use Cases

Use Case	5. Get Calculated Recent Schedule
Actors	System
Type	Hidden
Pre-Requisites	1개 이상의 Schedule이 존재
Typical Courses of Events	(A) Actor, (S) System 1. (S) 현재 시간과 Schedule 리스트들의 Schedule의 시간들을 비교 2. (S) 현재 시간과 가장 가까운 Schedule 1개 반환
Alternative Courses of Events	N/A
Exceptional Courses of Events	N/A

## 2041 Design Real Use Cases – Use Cases

Use Case	6. Set Current Time
Actors	User
Type	Evident
Pre-Requisites	현재 모드가 Time Keeping 모드
Typical Courses of Events	<p>(A) Actor, (S) System</p> <ol style="list-style-type: none"> <li>(A) Time Keeping 모드(Time Keeping Window-1)에서 버튼B를 누름</li> <li>(S) 현재 시간을 불러와 설정 화면(Time Keeping Window-2)으로 전환</li> <li>(A) 현재 시각 입력 값을 버튼 A(증가), 버튼 C(감소)로 설정(최댓값에서 A를 누르면 최솟값으로, 최솟값에서 C를 누르면 최댓값으로 변경)</li> <li>(A) 버튼 D를 눌러 단위 변경(시-&gt;분-&gt;초-&gt;연-&gt;월-&gt;일-&gt;시-&gt;...)</li> <li>(A) 3-4번을 반복하여 현재 시간 입력</li> <li>(A) 버튼 B 입력하여 현재 시간 설정 완료</li> <li>(S) 현재 시간 변경</li> <li>(S) 현재 시간 설정 화면(Time Keeping Window-2) 종료되어 Time Keeping 모드(Time Keeping Window-1)로 전환</li> </ol>
Alternative Courses of Events	<p>A3-1. 최댓값은 연=2099, 월=12, 일=해당 달에 맞는 일수, 시=23, 분=59, 초=59  A3-2. 최솟값은 연=1900, 월=1, 일=1, 시=0, 분=0, 초=0  A3-3. 월이 바뀌어 일수의 최댓값이 더 큰 달에서 작은 달로 바뀐다면, 해당 일수는 최솟값(1)로 바뀜  ex) 1월 31일에서 월을 2월로 바꾼다면, 자동적으로 2월 1일로 변환  A3-4. 각 단위의 값은 다른 단위 값에 영향을 주지 않는다. ex) 11시 59분 00초에서 1분을 증가시키면 12시가 아닌 11시 00분 00초가 됨</p>
Exceptional Courses of Events	N/A



## 2041 Design Real Use Cases – Use Cases

Use Case	7. Set Timer
Actors	User
Type	Evident
Pre-Requisites	현재 모드가 Timer 모드 현재 Timer가 흐르지 않고, Reset된 상태
Typical Courses of Events	(A) Actor, (S) System 1. (A) set timer(Timer Window-1)에서 시간 단위 값이 버튼 A를 누르면 증가(최댓값에서 A를 누르면 최솟값으로 변경) 2. (A) 버튼 C를 눌러 단위 변경 3. (A) 1-2번을 반복하여 타이머 시간 입력 4. (S) 버튼 B 이벤트가 발생 시 start timer(Timer Window-2)로 전환
Alternative Courses of Events	A1-1. 최댓값은 시=23, 분=59, 초=59 A1-2. 각 단위의 값은 다른 단위 값에 영향을 주지 않음 ex) 11시 59분 00초에서 1분을 증가시키면 12시가 아닌 11시 00분 00초가 됨
Exceptional Courses of Events	E0. 시간이 입력된 채로 버튼 D를 눌러 모드가 변경되면, reset timer(Timer Window-4)으로 전환

## 2041 Design Real Use Cases – Use Cases

Use Case	8. Start Timer
Actors	User
Type	Evident
Pre-Requisites	현재 모드가 Timer 모드 현재 Timer가 흐르지 않고, 타이머 시간이 초기값(0시 0분 0초)이 아님
Typical Courses of Events	(A) Actor, (S) System 1. (A) set timer(Timer Window-1)에서 버튼 B를 누름 2. (S) start timer(Timer Window-2)로 전환 3. (S) Timer 시간이 초 단위로 감소
Alternative Courses of Events	A3. Timer 시작 후, 다른 모드로 전환되었을 때에도 시간이 (돌아온 시점-전환 시점) 만큼 시간이 감소 A3. pause timer(Timer Window-3)에서 모드를 변경하지 않고 다시 시작 버튼을 눌렀을 때, start timer(Timer Window-2)로 전환되어 중단된 시간 부터 Timer 시간이 작동 (resume)
Exceptional Courses of Events	N/A

## 2041 Design Real Use Cases – Use Cases

Use Case	9. Pause Timer
Actors	User
Type	Evident
Pre-Requisites	현재 모드가 Timer 모드 현재 Timer가 흐르는 상태
Typical Courses of Events	(A) Actor, (S) System 1. (A) start timer(Timer Window-2)에서 버튼 B를 누름 2. (S) pause timer(Timer Window-3)로 전환되어 Timer 시간 일시정지 3. (S) Timer 시간 유지
Alternative Courses of Events	N/A
Exceptional Courses of Events	E0. 일시정지 후 모드를 변경한 뒤 다시 Timer 모드로 돌아왔을 때, reset timer(Timer Window-4)로 전환

## 2041 Design Real Use Cases – Use Cases

Use Case	10. Reset Timer
Actors	User
Type	Evident
Pre-Requisites	현재 모드가 Timer 모드 현재 Timer가 일시정지
Typical Courses of Events	(A) Actor, (S) System 1. (A) Pause Timer(Timer Window-3)에서 버튼 B를 3초 이상 누름 2. (S) Reset Timer(Timer Window-4)로 전환되어 Timer 시간을 Reset 3. (S) Timer 시간을 0시 0분 0초로 설정
Alternative Courses of Events	N/A
Exceptional Courses of Events	N/A

## 2041 Design Real Use Cases – Use Cases

Use Case	11. Start Stopwatch
Actors	User
Type	Evident
Pre-Requisites	현재 모드가 Stopwatch 모드 현재 Stopwatch가 흐르지 않는 상태
Typical Courses of Events	(A) Actor, (S) System 1. (A) Stopwatch 모드(StopWatch Window-1)에서 버튼 B를 누름 2. (S) Start Stopwatch (StopWatch Window-2)로 전환 3. (S) Stopwatch 시간이 초 단위로 증가
Alternative Courses of Events	A2. Stopwatch 시작 후, 다른 모드로 전환되었을 때에도 시간이 (돌아온 시점-전환 시점) 만큼 시간이 증가 A2. pause stopwatch(StopWatch Window-3)에서 모드를 변경하지 않고 다시 시작 버튼을 눌렀을 때, start stopwatch(StopWatch Window-2)로 전환되어 중단된 시간부터 Stopwatch 시간이 작동 (resume)
Exceptional Courses of Events	N/A

## 2041 Design Real Use Cases – Use Cases

Use Case	12. Pause Stopwatch
Actors	User
Type	Evident
Pre-Requisites	현재 모드가 Stopwatch 모드 현재 Stopwatch가 흐르는 상태
Typical Courses of Events	(A) Actor, (S) System 1. (A) start stopwatch(StopWatch Window-2)에서 버튼 B를 누름 2. (S) pause stopwatch(StopWatch Window-3)로 전환되어 Stopwatch 시간 일시중지 3. (S) Stopwatch 시간 유지
Alternative Courses of Events	N/A
Exceptional Courses of Events	E0. 일시정지 후 버튼 D를 눌러 모드를 변경한 뒤 다시 Stopwatch 모드로 돌아왔을 때, reset stopwatch(StopWatch Window-4)로 전환

## 2041 Design Real Use Cases – Use Cases

Use Case	13. Reset Stopwatch
Actors	User
Type	Evident
Pre-Requisites	현재 모드가 Stopwatch 모드 현재 Stopwatch가 일시정지 상태
Typical Courses of Events	(A) Actor, (S) System 1. (A) pause stopwatch(StopWatch Window-3)에서 버튼 B를 3초 이상 누름 2. (S) reset stopwatch(StopWatch Window-4)로 전환되어 stopwatch 시간 Reset 3. (S) Stopwatch 시간을 0시 0분 0초로 설정
Alternative Courses of Events	N/A
Exceptional Courses of Events	N/A

## 2041 Design Real Use Cases – Use Cases

Use Case	14. Get Listed Alarm
Actors	System
Type	Hidden
Pre-Requisites	1개 이상의 Alarm 존재
Typical Courses of Events	(A) Actor, (S) System 1. (S) Alarm 모드에서, Alarm 리스트 화면(Alarm Window-1)에 Alarm 정렬 기준(시/분/초)에 따라 오름차순 정렬 2. (S) 정렬 기준 값이 같은 경우, Alarm의 등록 혹은 수정 순서대로 정렬
Alternative Courses of Events	N/A
Exceptional Courses of Events	N/A



## 2041 Design Real Use Cases – Use Cases

Use Case	15. Set Alarm
Actors	User
Type	Evident
Pre-Requisites	현재 모드가 Alarm 모드 생성된 Alarm 개수가 3개 이하
Typical Courses of Events	<p>(A) Actor, (S) System</p> <ol style="list-style-type: none"> <li>(A) Alarm 모드(Alarm Window-1)에서, 버튼 B를 3초 이상 누름</li> <li>(S) Alarm 설정 화면(Alarm Window-2)으로 전환</li> <li>(A) Alarm 단위 값을 버튼 A(증가), 버튼 C(감소)로 설정(최댓값에서 A를 누르면 최솟값으로, 최솟값에서 C를 누르면 최댓값으로 변경)</li> <li>(A) 버튼 D를 눌러 단위 변경(시-&gt;분-&gt;초)</li> <li>(A) 3-4번을 반복하여 Alarm 정보 입력</li> <li>(A) 버튼 B 입력하여 Alarm 추가를 완료</li> <li>(S) Enable 한 상태의 새로운 Alarm 생성</li> <li>(S) Alarm 설정 화면(Alarm Window-2)이 종료되어 Alarm모드 (Alarm Window-1)로 돌아간다.</li> </ol>
Alternative Courses of Events	<p>A3-1. 최댓값은 시=23, 분=59, 초=59  A3-2. 최솟값은 시=0, 분=0, 초=0  A3-3. 각 단위의 값은 다른 단위 값에 영향을 주지 않음  ex) 11시 59분 00초에서 에서 1분을 증가시키면 12시가 아닌 11시 00분 00초가 됨  A7. Alarm 값이 입력되지 않은 채로 종료된 단위는 초기값(0시 0분 0초)으로 저장</p>
Exceptional Courses of Events	N/A

## 2041 Design Real Use Cases – Use Cases

Use Case	16. Enable Alarm
Actors	User
Type	Evident
Pre-Requisites	현재 모드가 Alarm 모드 생성된 Alarm 개수가 1개 이상 선택된 Alarm이 비활성화 상태
Typical Courses of Events	(A) Actor, (S) System 1. (A) Alarm 모드(Alarm Window-1)에서 버튼A(올라감), 버튼C(내려감)을 통해, 커서를 이동 2. (A) Alarm 모드(Alarm Window-1)에서 커서가 원하는 Alarm일 때, 버튼 A를 3초 이상 누름 3. (S) 선택된 Alarm을 활성화 상태로 전환
Alternative Courses of Events	A1. 마지막 Alarm에서 버튼 C를 누르거나, 첫번째 Alarm에서 버튼 A를 누르면 반응하지 않음
Exceptional Courses of Events	N/A

## 2041 Design Real Use Cases – Use Cases

Use Case	17. Disable Alarm
Actors	User
Type	Evident
Pre-Requisites	현재 모드가 Alarm 모드 생성된 Alarm 개수가 1개 이상 선택된 Alarm이 활성화 상태
Typical Courses of Events	(A) Actor, (S) System 1. (A) Alarm 모드(Alarm Window-1)에서 버튼A(올라감), 버튼C(내려감)을 통해, 커서를 이동 2. (A) Alarm 모드(Alarm Window-1)에서 커서가 원하는 Alarm일 때, 버튼 A를 3초 이상 누름 3. (S) 선택된 Alarm을 비활성화 상태로 전환
Alternative Courses of Events	마지막 Alarm에서 버튼 C를 누르거나, 첫번째 Alarm에서 버튼 A를 누르면 반응하지 않음
Exceptional Courses of Events	N/A

## 2041 Design Real Use Cases – Use Cases

Use Case	18. Modify Alarm
Actors	User
Type	Evident
Pre-Requisites	현재 모드가 Alarm 모드, 1개 이상의 Alarm이 존재
Typical Courses of Events	<p>(A) Actor, (S) System</p> <ol style="list-style-type: none"> <li>(A) Alarm 모드(Alarm Window-1)에서 버튼 B를 누름</li> <li>(S) Alarm의 기존 값을 불러와 설정 화면(Alarm Window-2)으로 전환한다.</li> <li>(A) Alarm 단위 값을 버튼 A(증가), 버튼 C(감소)로 설정(최댓값에서 A를 누르면 최솟값으로, 최솟값에서 C를 누르면 최댓값으로 변경)</li> <li>(A) 버튼 D를 눌러서 단위를 변경 (시-)&gt;분-&gt;초</li> <li>(A) 3번과 4번을 반복하여 Alarm 정보 입력</li> <li>(A) 버튼 B 입력하여 Alarm 수정 완료</li> <li>(S) Alarm 정보를 수정</li> <li>(S) Alarm 설정 화면(Alarm Window-2)을 종료되어 Alarm모드(Alarm Window-1)로 돌아감</li> </ol>
Alternative Courses of Events	<p>A1. 마지막 Schedule에서 버튼 C를 누르거나, 첫번째 Schedule에서 버튼 A를 누르면 반응하지 않음</p> <p>A3-1. 최댓값은 시=23, 분=59, 초=59</p> <p>A3-2. 최솟값은 시=0, 분=0, 초=0</p> <p>A3-3. 각 단위의 값은 다른 단위 값에 영향을 주지 않음</p> <p>ex) 11시 59분 00초에서 에서 1분을 증가시키면 12시가 아닌 11시 00분 00초가 됨</p>
Exceptional Courses of Events	N/A

## 2041 Design Real Use Cases – Use Cases

Use Case	19. Delete Alarm
Actors	User
Type	Evident
Pre-Requisites	현재 모드가 Alarm 모드 1개 이상의 Alarm이 존재
Typical Courses of Events	(A) Actor, (S) System 1. (A) Alarm 모드(Alarm Window-1)에서 버튼 A(올라감), 버튼 C(내려감)을 통해, 커서를 이동 2. (A) Alarm 모드(Alarm Window-1)에서 커서가 원하는 Alarm일 때, 버튼 C를 3초 이상 누름 3. (S) 선택된 Alarm 삭제
Alternative Courses of Events	A1. 마지막 Schedule에서 버튼 C를 누르거나, 첫번째 Schedule에서 버튼 A를 누르면 반응하지 않음
Exceptional Courses of Events	N/A

## 2041 Design Real Use Cases – Use Cases

Use Case	20. Get Listed World Time
Actors	System
Type	Hidden
Pre-Requisites	현재 모드가 World Time 모드
Typical Courses of Events	(A) Actor, (S) System 1. (S) 나라별 세계 시간을 GMT 순서대로 제공
Alternative Courses of Events	N/A
Exceptional Courses of Events	N/A

## 2041 Design Real Use Cases – Use Cases

Use Case	21. Change Mode
Actors	User
Type	Evident
Pre-Requisites	현재, 각 모드의 설정 화면이 아닌 기본 화면
Typical Courses of Events	(A) Actor, (S) System 1. (A) 버튼 D를 누름 2. (S) 사용자가 선택한 모드 4개가 Time Keeping, Timer, Stopwatch, Alarm, World Time, Scheduling 순서로 전환
Alternative Courses of Events	N/A
Exceptional Courses of Events	N/A

## 2041 Design Real Use Cases – Use Cases

Use Case	22. Select Mode
Actors	User
Type	Evident
Pre-Requisites	현재 모드가 Time Keeping 모드
Typical Courses of Events	<p>(A) Actor, (S) System</p> <ol style="list-style-type: none"> <li>(A) Time Keeping(Time Keeping Window-1)에서 버튼 D를 3초 이상 누름</li> <li>(S) Select Mode(Select Mode Window-1)로 전환</li> <li>(A) 버튼 A(이전 항목)와 버튼 C(다음 항목)을 이용해 포인터 위치 변경 (Time Keeping 은 선택할 수 없음)</li> <li>(A) 버튼 B로 모드의 활성화/비활성화 상태 결정 (ON/OFF 토글 방식)</li> <li>(A) 버튼 D를 눌러 선택 모드 설정 완료</li> <li>(S) Time Keeping을 포함한 모드 4개 활성화</li> <li>(S) Select Mode 화면 (Select Mode Window-1) 을 종료 하여 Timekeeping Mode(Time Keeping Window-1)로 전환</li> </ol>
Alternative Courses of Events	<p>A3. 처음 mode 에서 버튼 A를 누르거나, 마지막 mode에서 버튼 C를 누르면 반응하지 않음</p> <p>A5. 선택된 모드가 4개가 아니면 버튼 D 입력 무시</p>
Exceptional Courses of Events	N/A



## 2041 Design Real Use Cases – Use Cases

Use Case	23. Back To Default Mode
Actors	User
Type	Hidden
Pre-Requisites	현재 모드가 Default Mode(세팅하지 않는 Time Keeping Mode) (Time Keeping Window-1), Timer가 작동중인 Mode(Timer window - 2), Stopwatch가 작동중인 Mode(Stopwatch window - 2)가 아닌 다른 모든 모드
Typical Courses of Events	(A) Actor, (S) System 1. (S) 현재 화면에서 1분 이상 동안 아무런 입력이 없는지 확인 2. (S) Default Mode(Time Keeping) (Time Keeping Window-1)로 화면 전환
Alternative Courses of Events	N/A
Exceptional Courses of Events	N/A

## 2041 Design Real Use Cases – Use Cases

Use Case	24. Beep
Actors	System
Type	Hidden
Pre-Requisites	설정된 알람의 시간과 현재 시간이 일치하거나, 설정된 타이머의 시간이 0인 상태
Typical Courses of Events	(A) Actor, (S) System 1. (S) 화면에 Beep 팝업 출력
Alternative Courses of Events	A1. 이미 한 개의 Beep 팝업이 실행되고 있으면, 그 위에 Beep 팝업이 쌓여 출력
Exceptional Courses of Events	N/A

## 2041 Design Real Use Cases – Use Cases





Use Case	25. Mute Beep
Actors	User
Type	Evident
Pre-Requisites	Beep이 실행되고 있는 상태
Typical Courses of Events	(A) Actor, (S) System 1. (A) 아무 버튼이나 입력 2. (S) 화면에 Beep 팝업 종료
Alternative Courses of Events	A2. 여러 개의 Beep 팝업이 실행되고 있으면, 버튼 입력 한 번에 한 개의 팝업 종료
Exceptional Courses of Events	N/A

## 2041 Design Real Use Cases – Use Cases





Use Case	26. Display
Actors	System
Type	Hidden
Pre-Requisites	시계가 작동 중인 상태
Typical Courses of Events	(A) Actor, (S) System 1. (S) 각 모드와 상황에 맞는 화면을 출력
Alternative Courses of Events	N/A
Exceptional Courses of Events	N/A

## 2042 Define Reports, UI and Storyboards – UI

Time Keeping(Time Keeping Window – 1)





A	ETC 05.25 13:30	B
<h1>10:12:40</h1> <p>2020 01.01</p>		
C	   	D

Set Current Time(Time Keeping Window – 2)





A		B
<h1><u>10</u>:12:40</h1> <p>2020 01.01</p>		
C	   	D

## 2042 Define Reports, UI and Storyboards – UI





Schedule Mode(Schedule window – 1)

A	12:51:30	B
	ETC 05.25 13:30	
	CLA 05.27 15:20	
C	   	D





Add Schedule(Schedule window – 2)

A	12:51:30	B
	<u>09:00</u>	
	CLA 01.01	
C	   	D

Modify Schedule(Schedule Window – 3)





A	12:51:30	B
	<u>10:12</u>	
	CLA 01.01	
C	   	D

Delete Schedule(in Schedule Window – 1)

A	12:51:30	B
	ETC 05.25 13:30	
	CLA 05.27 15:20	
C	   	D





## 2042 Define Reports, UI and Storyboards – UI

Get Calculated Recent Schedule (in Time keeping Window-1)





A	ETC 05.25 13:30	B
<h1>10:12:40</h1> <p>2020 01.01</p>		
C	   	D







Set Timer(Timer window – 1)

A	12:51:30	B
	<u>03:07:31</u>	
C	   	D





Start Timer(Timer window – 2)

A	12:51:30	B
	03:07:31	
C	   	D

Pause Timer(Timer Window – 3)





A	12:51:30	B
	03:07:31	
C	   	D

Reset Timer(Timer Window – 4)





A	12:51:30	B
	00:00:00	
C	   	D

## 2042 Define Reports, UI and Storyboards – UI

StopWatch Mode(Stopwatch Window – 1)





A	12:51:30	B
00:00:00		
C	   	D

Start Stopwatch(Stopwatch Window – 2)





A	12:51:30	B
00:00:01		
C	   	D

## 2042 Define Reports, UI and Storyboards – UI

Pause Stopwatch(Stopwatch Window – 3)





A	12:51:30	B
	00:00:34	
C	   	D

Reset Stopwatch(Stopwatch Window – 4)





A	12:51:30	B
	00:00:00	
C	   	D

## 2042 Define Reports, UI and Storyboards – UI

Alarm Mode (Alarm Window – 1)





A	12:51:30	B
	[OFF] 13:30:20	
	[OFF] 15:20:42	
C	   	D

Set Alarm(Alarm Window – 2)





A	12:51:30	B
	<u>09:30:00</u>	
C	   	D

## 2042 Define Reports, UI and Storyboards – UI





Enable Alarm(in Alarm window-1)

A	12:51:30	B
	[OFF] 13:30:20	
	[ON] 15:20:42	
C	   	D





Disable Alarm(in Alarm window – 1)

A	12:51:30	B
	[OFF] 13:30:20	
	[OFF] 15:20:42	
C	   	D

Modify Alarm(Alarm window – 3)





A	12:51:30	B
	<u>13:30:20</u>	
C	   	D

Delete Alarm(in Alarm Window – 1)







A	12:51:30	B
	[OFF] 13:30:20	
	[OFF] 15:20:42	
C	   	D

## 2042 Define Reports, UI and Storyboards – UI

World Time Mode(World Time Window – 1)

A	[GMT-5][New York] 13:30:30	B
	[GMT+0][London] 03:51:30	
	[GMT+2][Paris] 05:51:30	
	[GMT+2][Rome] 05:51:30	
	[GMT+8][Beijing] 11:51:30	
	[GMT+9][Tokyo] 12:51:30	
C	   	D

Select Mode(Select Mode window – 1)

A	 Time Keeping	B
	 Timer	
	 Stop Watch	
	 Alarm	
	 World Time	
	 Schedule	
C		D



Beep(Beep Alarm Window-1)

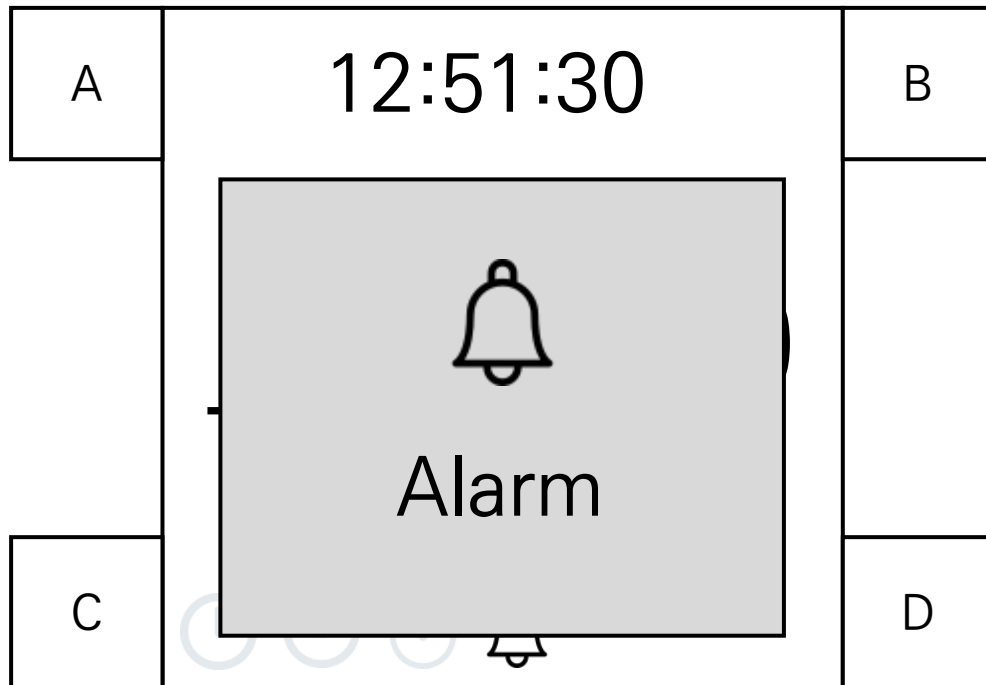

Beep(Beep Timer Window - 1)

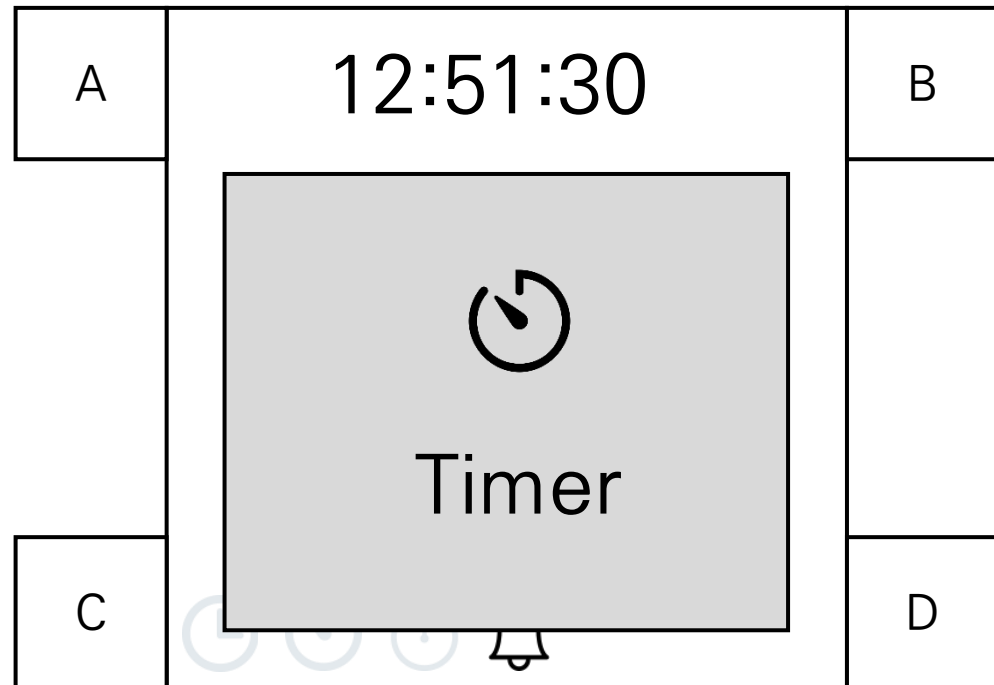

## 2043 Define Interaction Diagrams – 2. Add Schedule

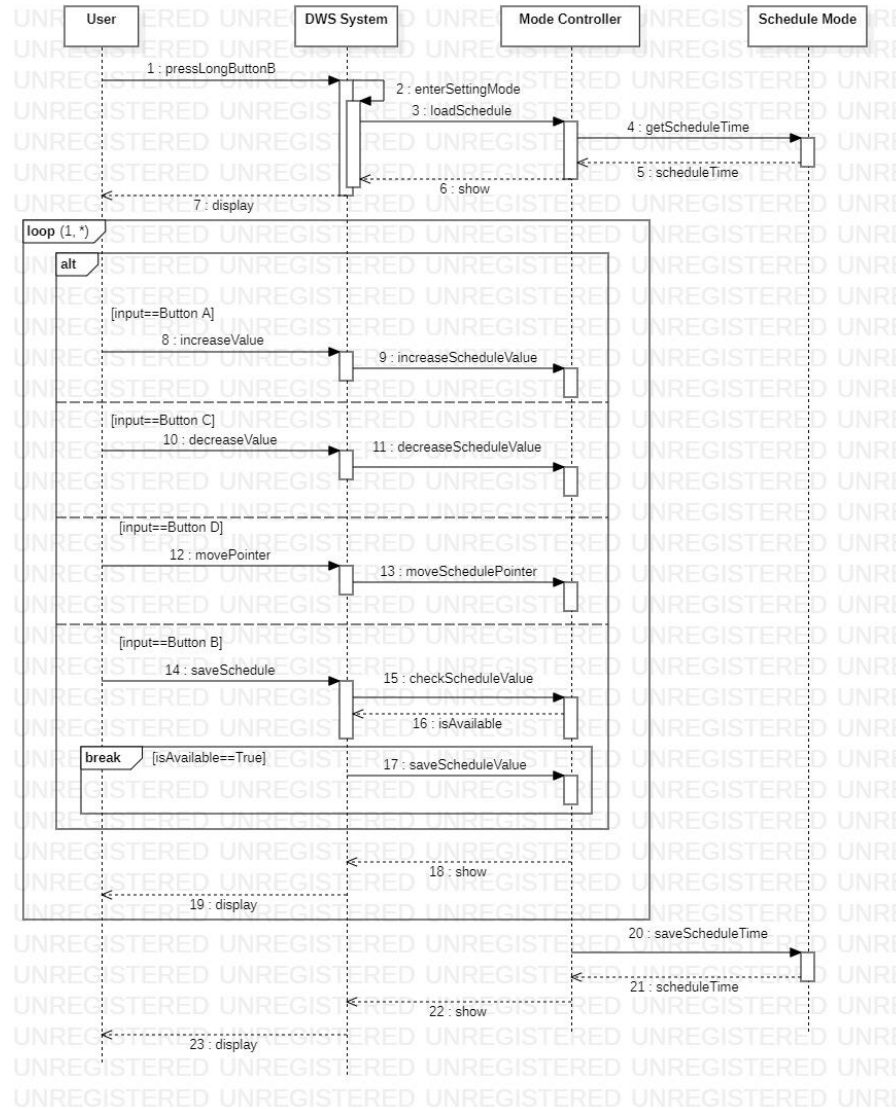

## 2043 Define Interaction Diagrams – 3. Modify Schedule

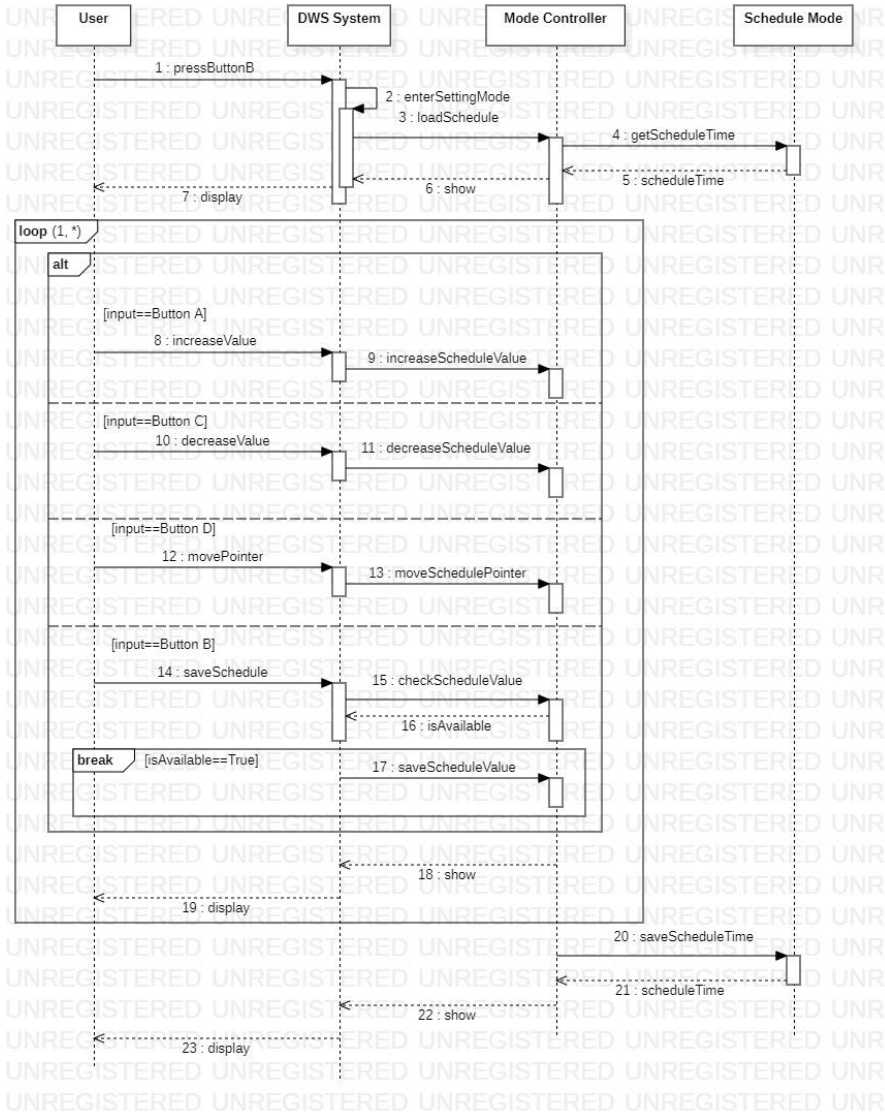

## 2043 Define Interaction Diagrams – 4. Delete Schedule

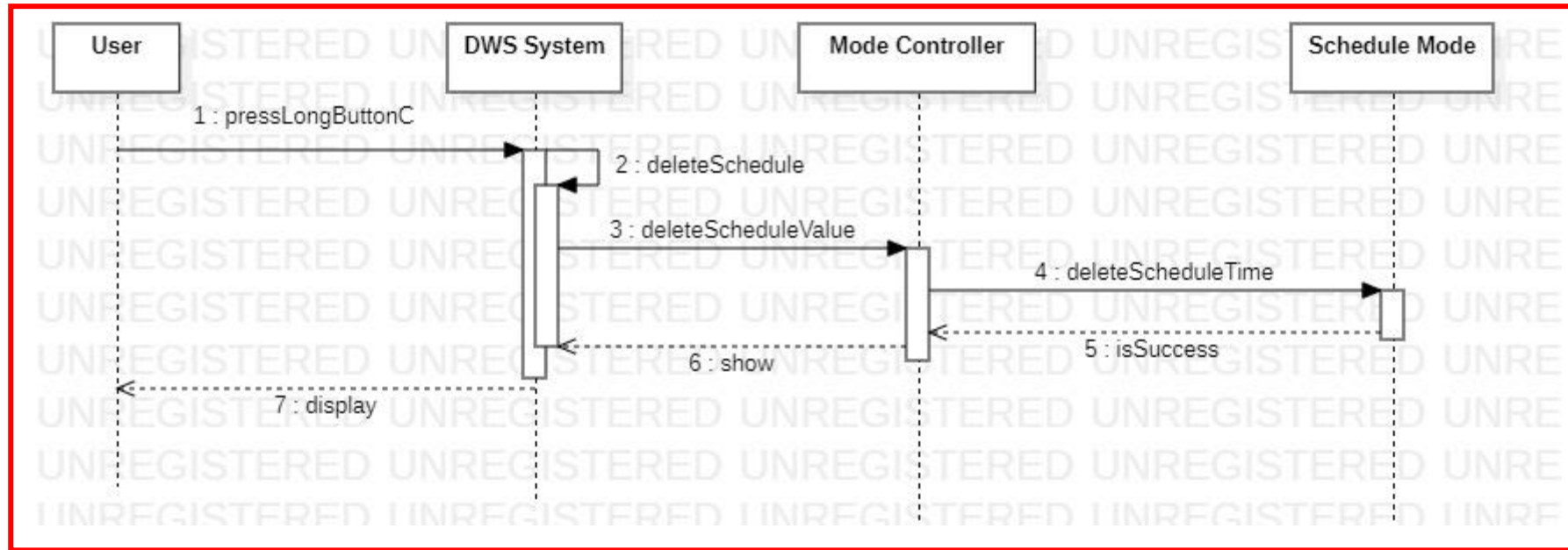

## 2043 Define Interaction Diagrams – 6. Set Current Time

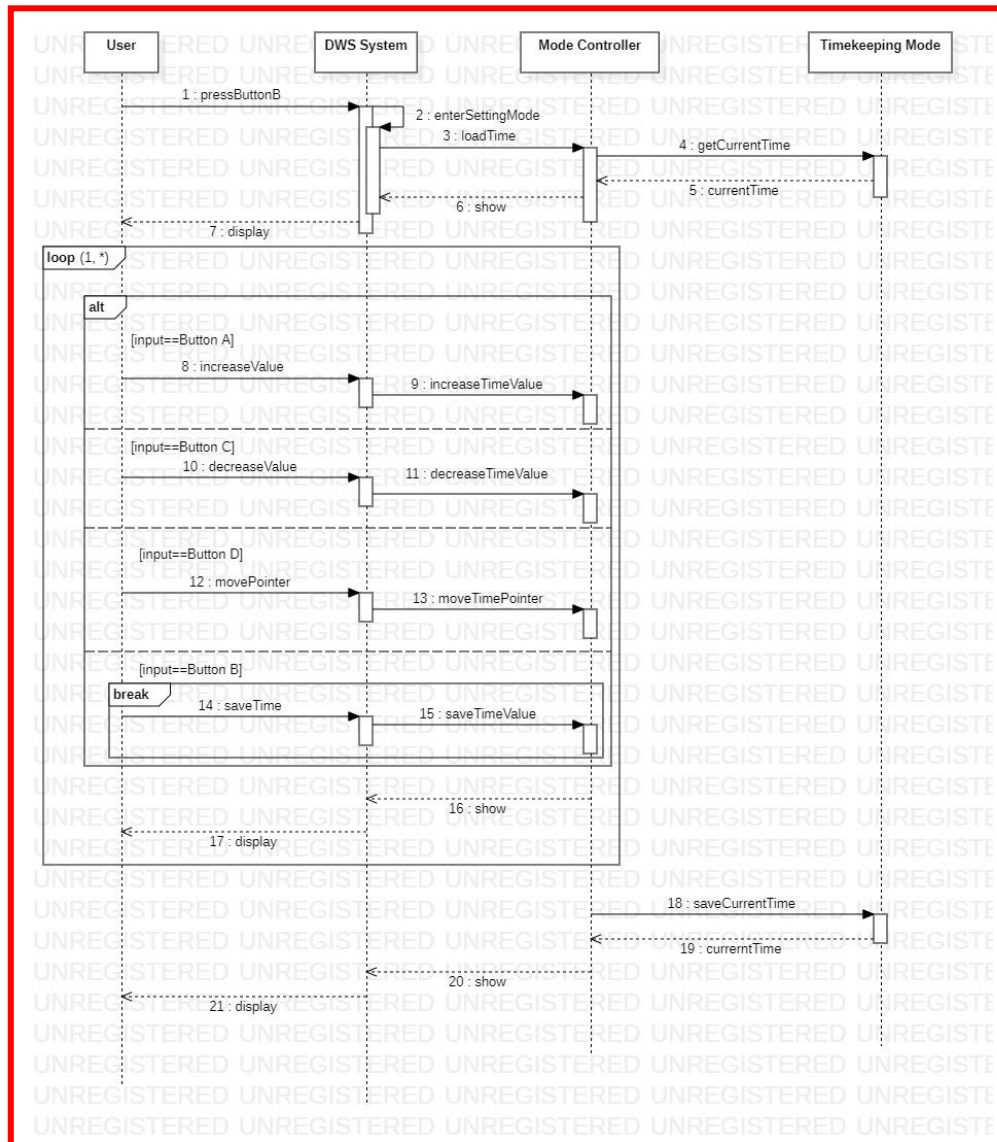

## 2043 Define Interaction Diagrams – 7. Set Timer

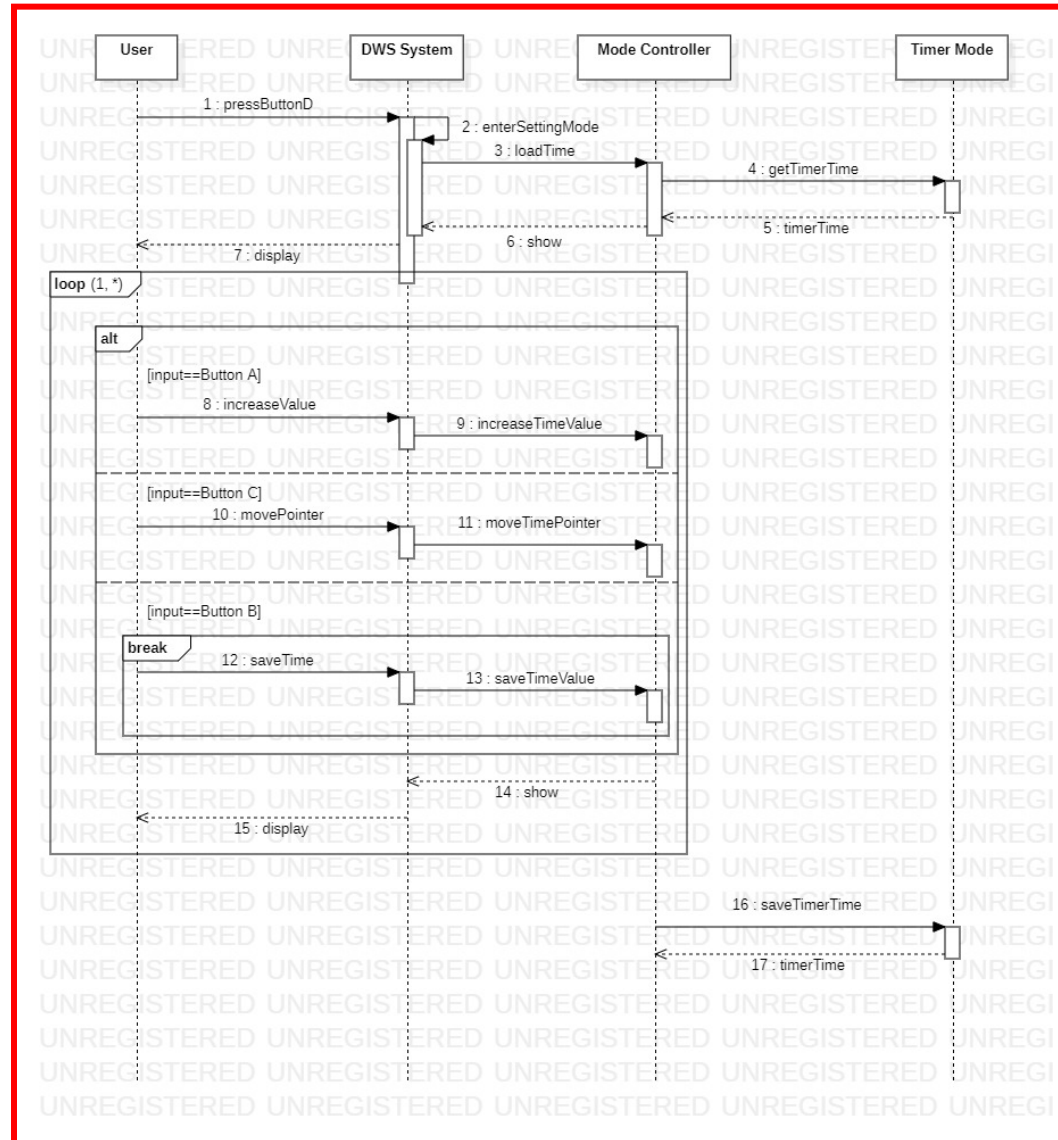

## 2043 Define Interaction Diagrams – 8. Start Timer

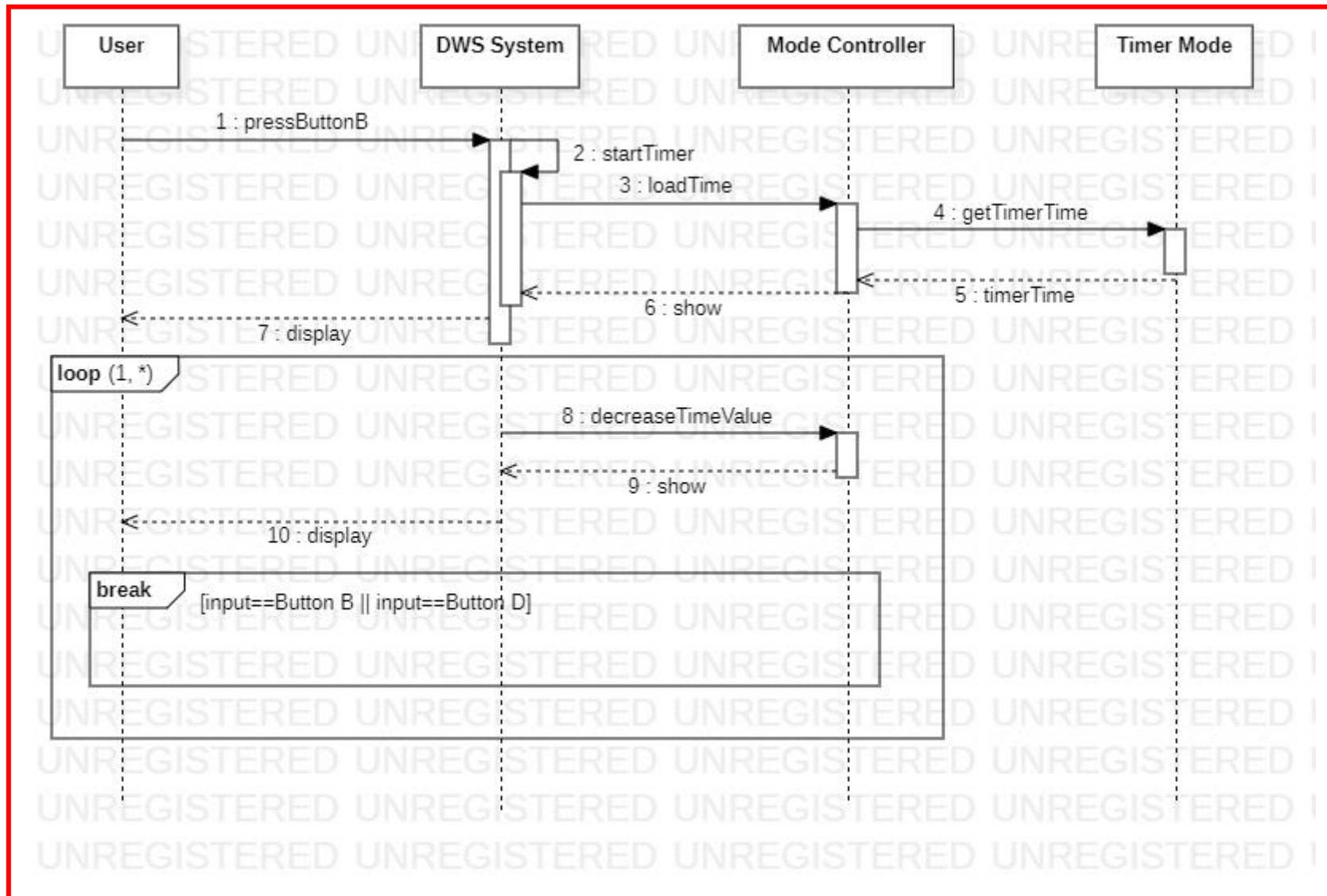

## 2043 Define Interaction Diagrams – 9. Pause Timer

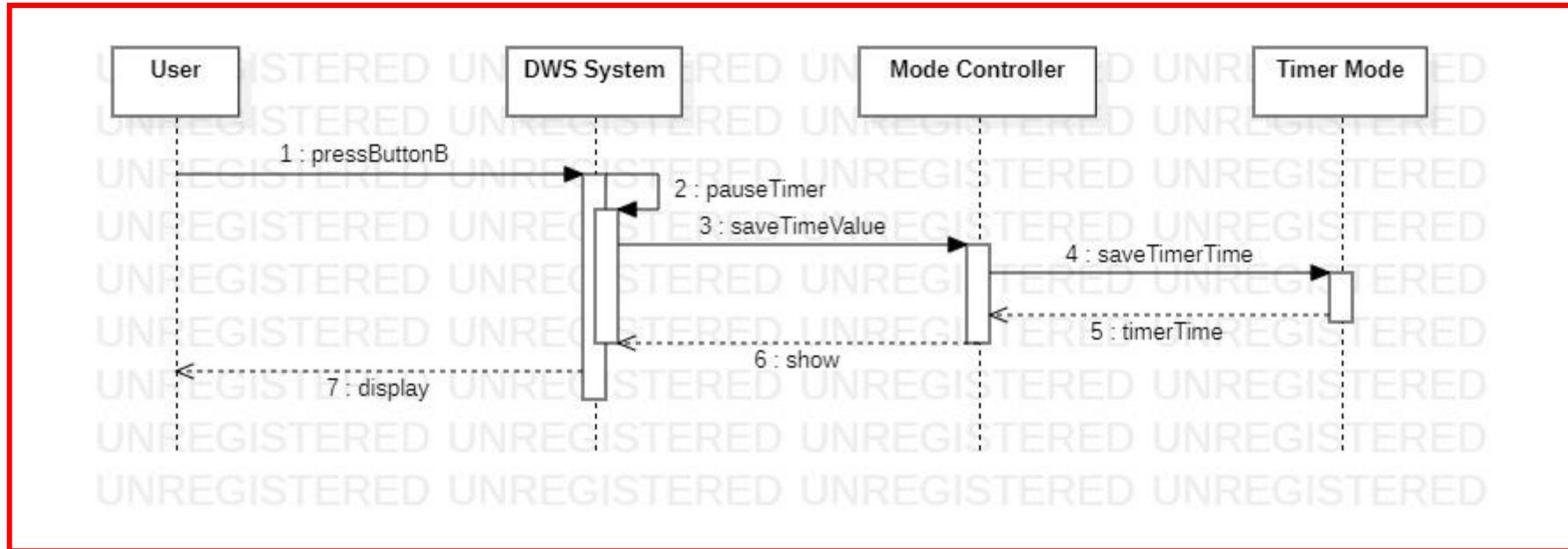



## 2043 Define Interaction Diagrams – 10. Reset Timer

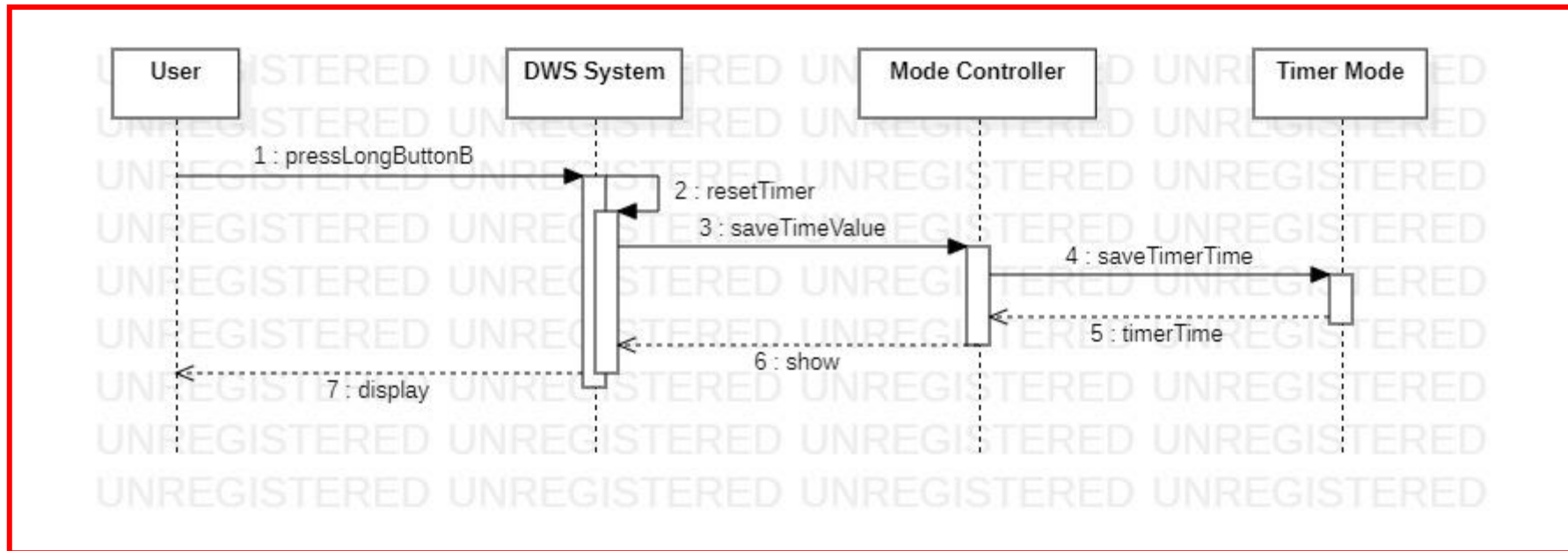

## 2043 Define Interaction Diagrams – 11. Start Stopwatch

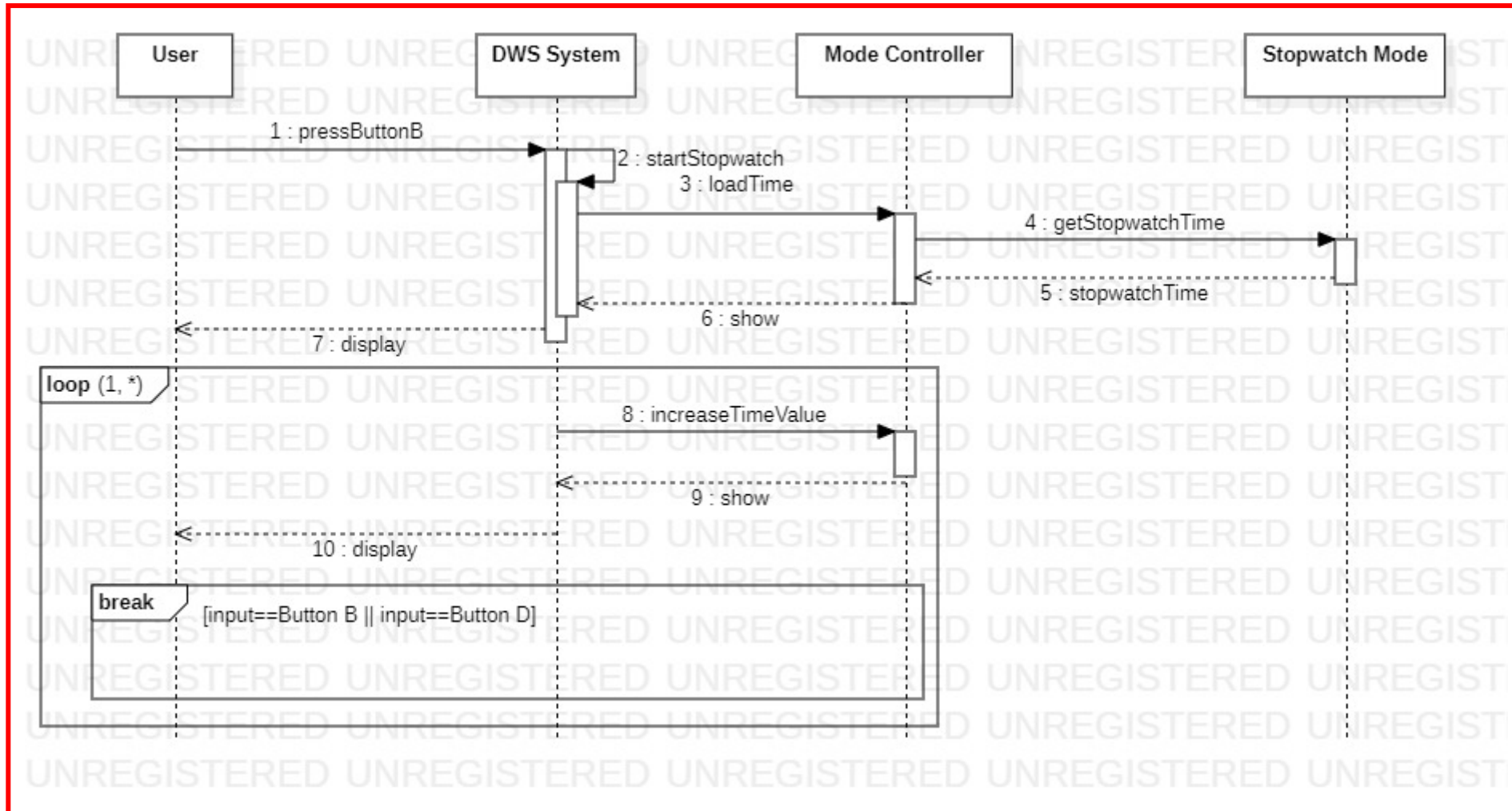

## 2043 Define Interaction Diagrams – 12. Pause Stopwatch

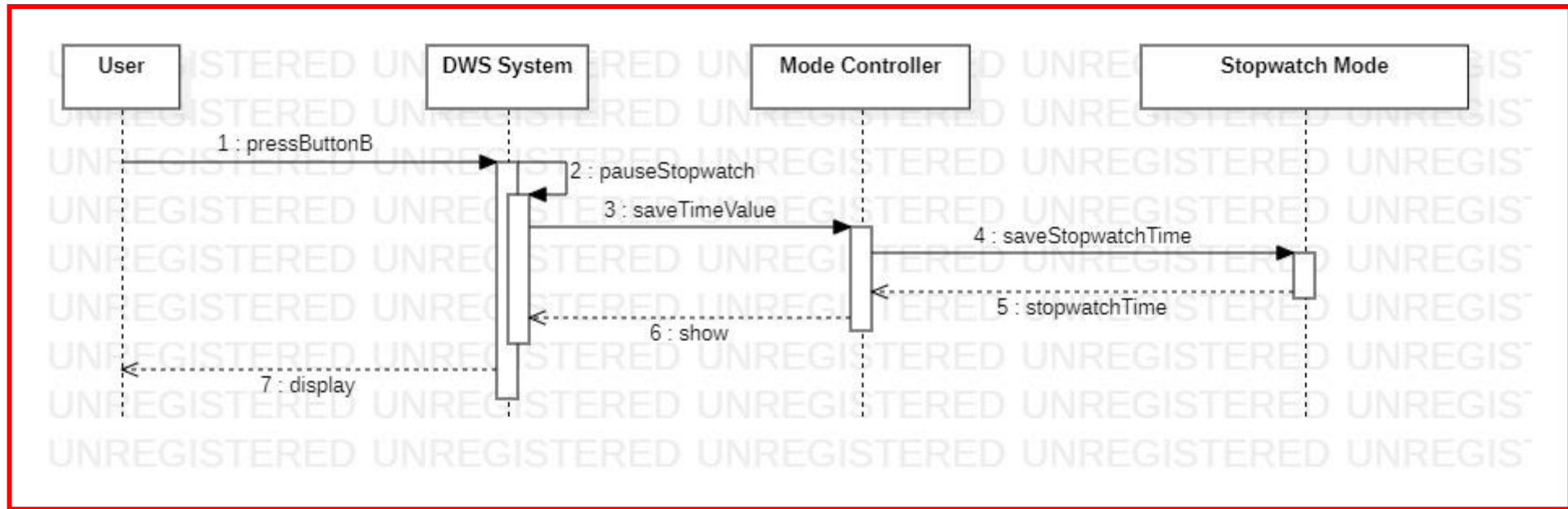

## 2043 Define Interaction Diagrams – 13. Reset Stopwatch

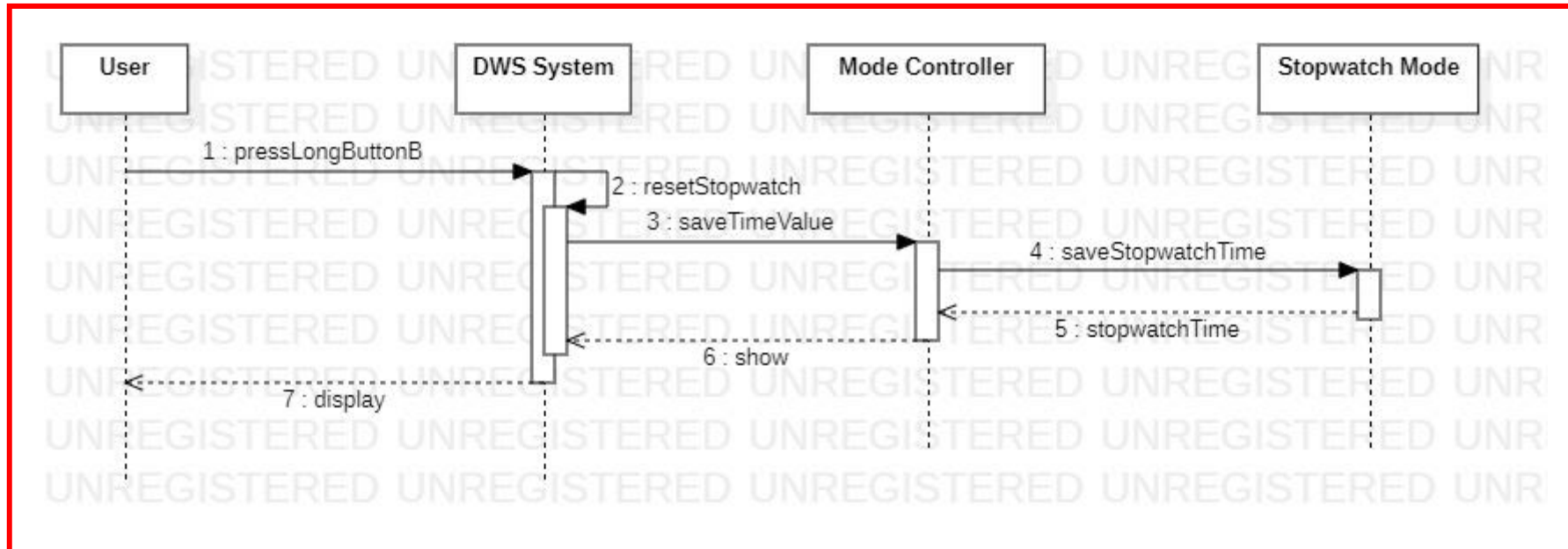

## 2043 Define Interaction Diagrams – 15. Set Alarm

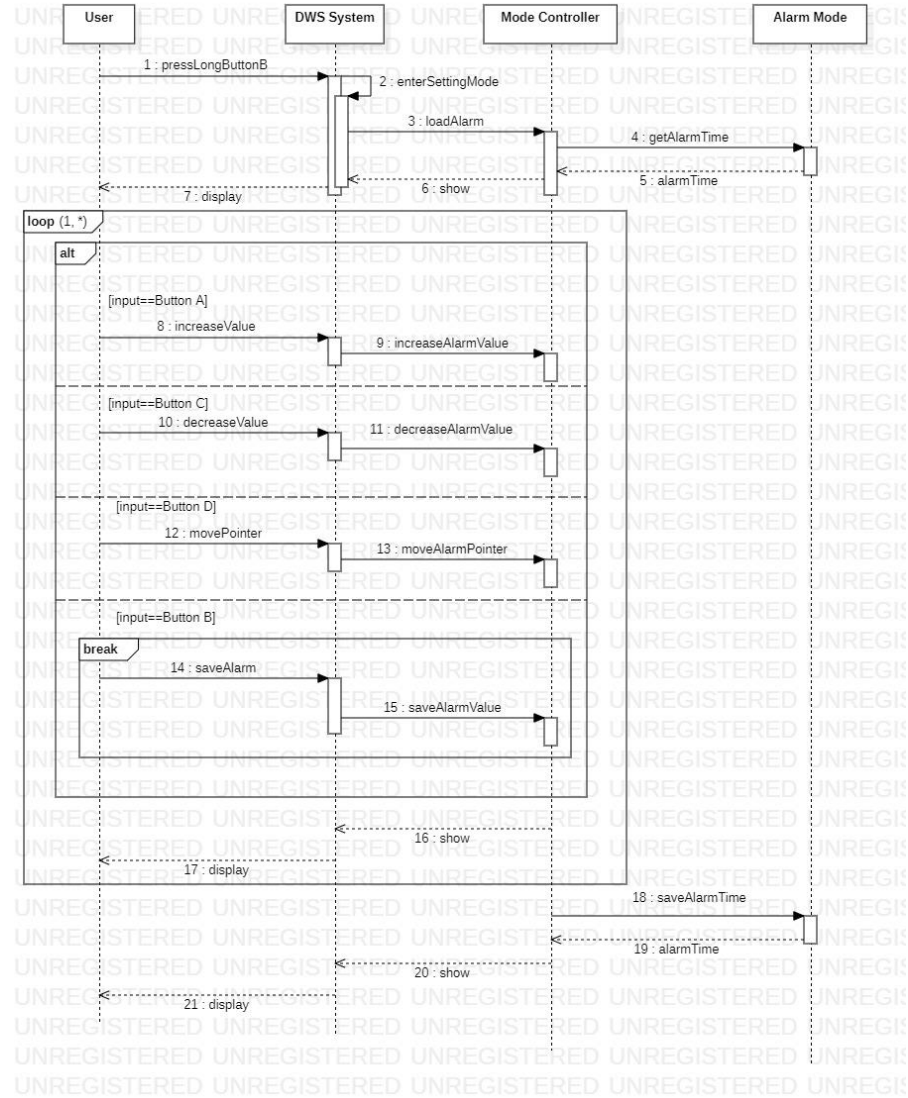

## 2043 Define Interaction Diagrams – 16. Enable Alarm

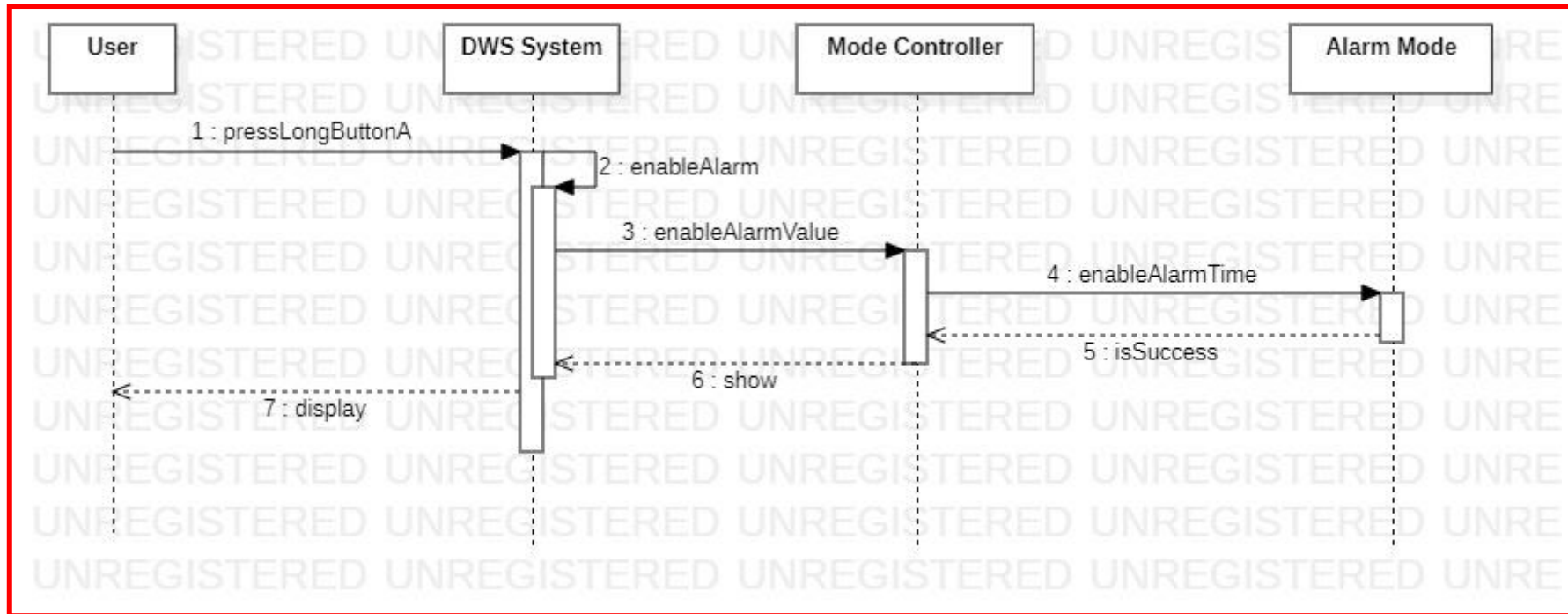

## 2043 Define Interaction Diagrams – 17. Disable Alarm

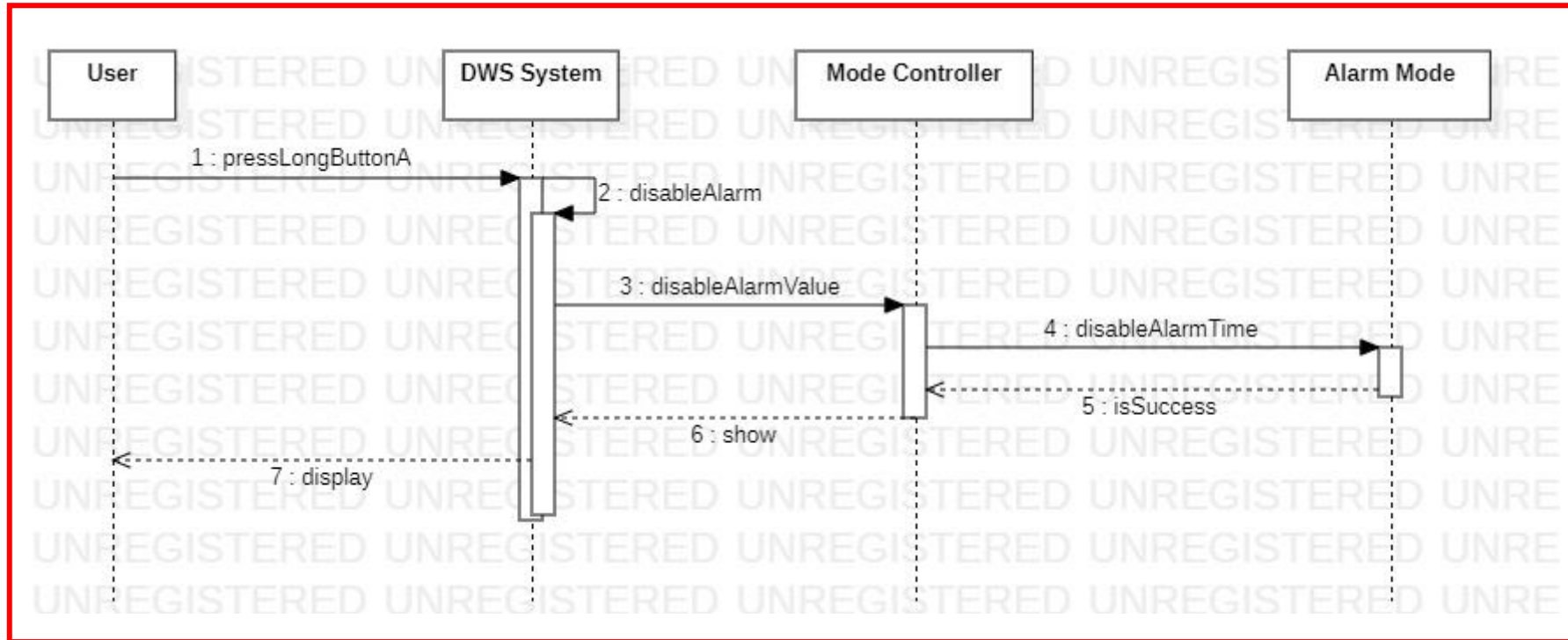

## 2043 Define Interaction Diagrams – 18. Modify Alarm

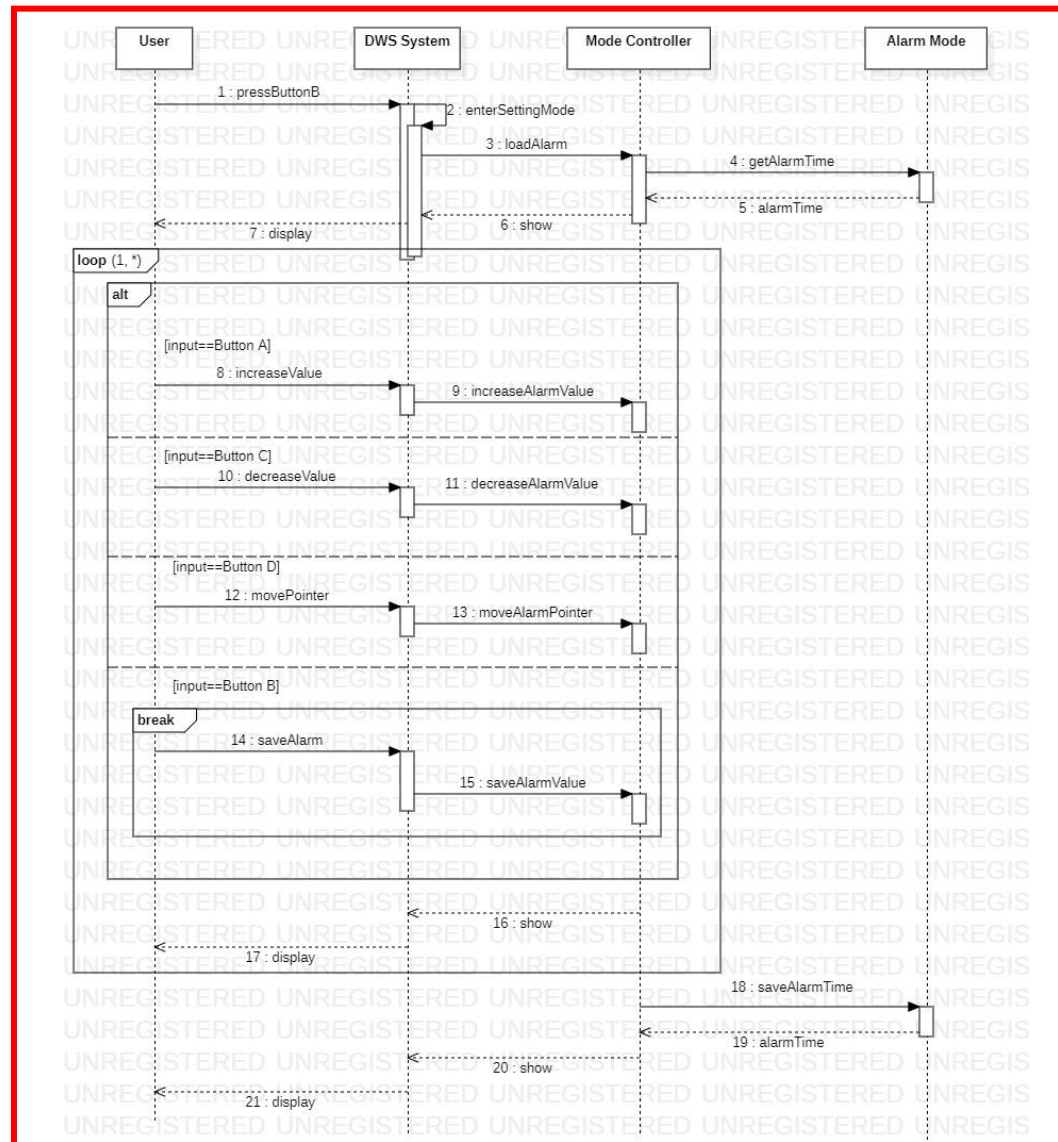



## 2043 Define Interaction Diagrams – 19. Delete Alarm

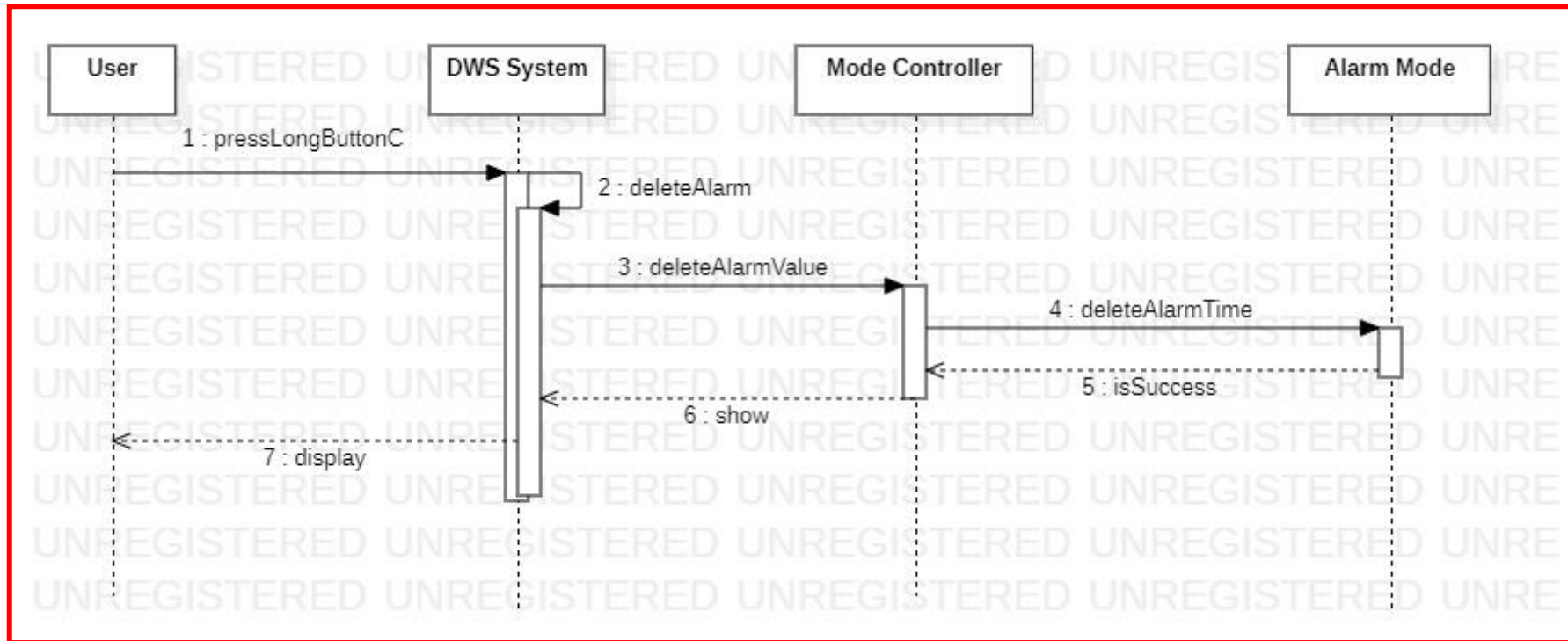

## 2043 Define Interaction Diagrams – 21. Change Mode

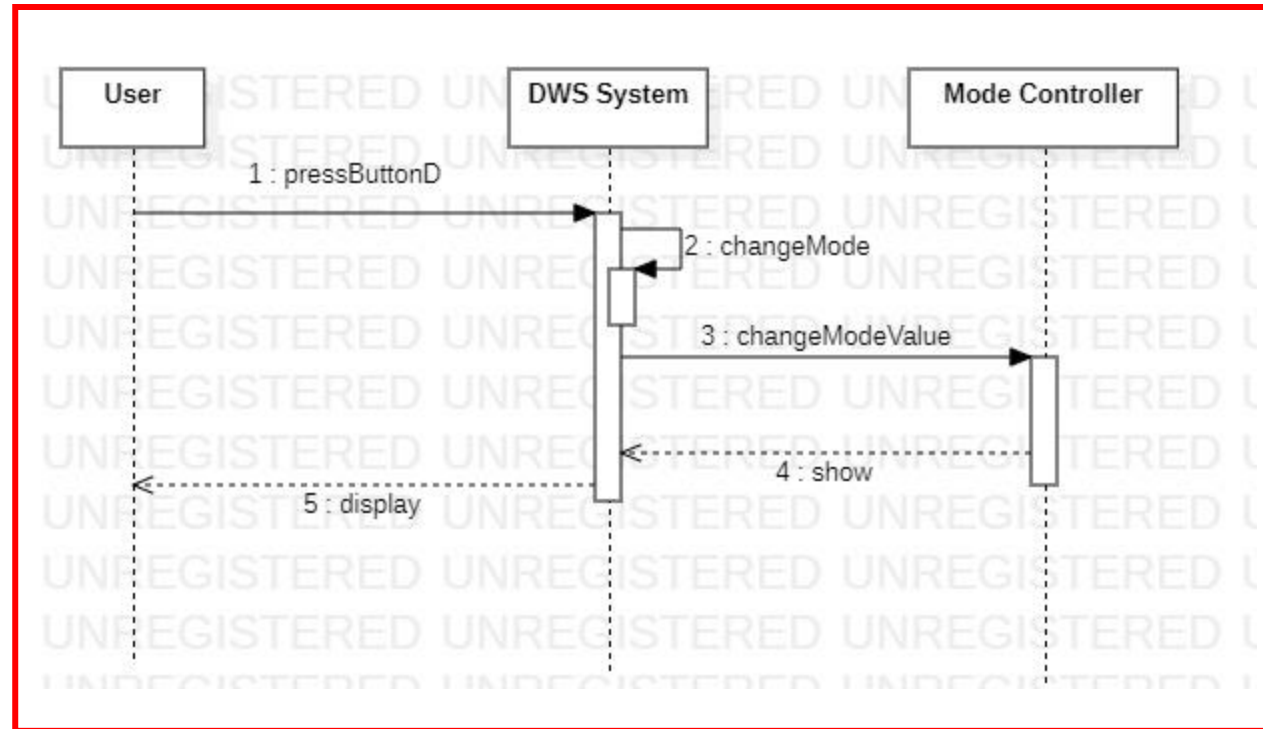

## 2043 Define Interaction Diagrams – 22. Select Mode

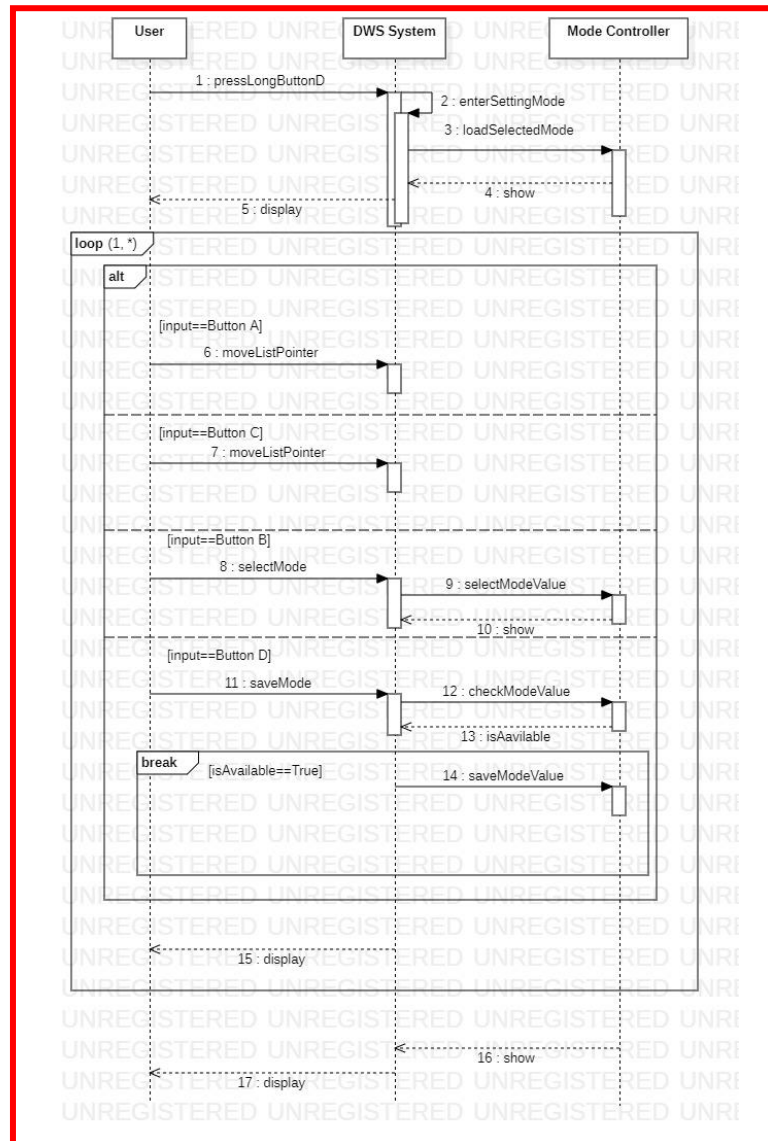

## 2043 Define Interaction Diagrams – 25. Mute Beep

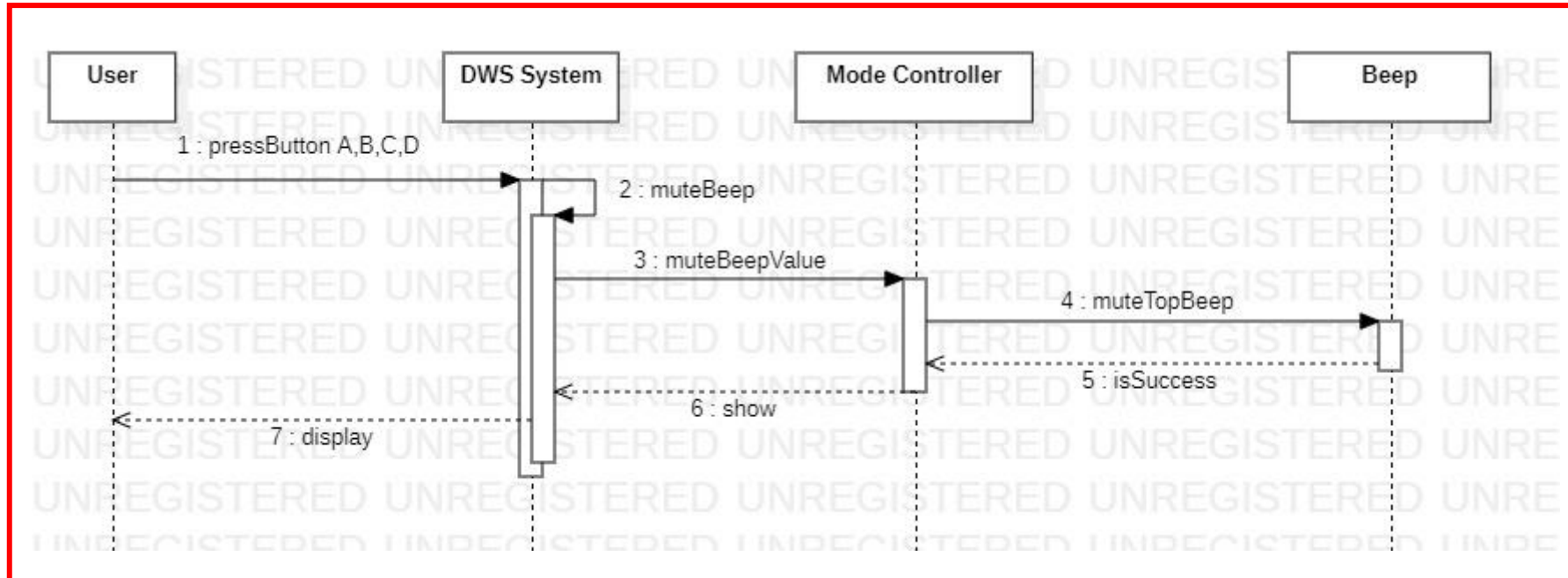



# 2047 Perform 2040 Traceability Analysis

Essential Use Case	S-Link
1. GetListedSchedule	(Hidden)
2. AddSchedule	S1, S2, S3, S4, S5
3. ModifySchedule	S1, S2, S3, S4, S5
4. DeleteSchedule	S6
5. GetCalculatedRecentSchedule	(Hidden)
6. SetCurrentTime	S1, S2, S3, S4, S7
7. SetTimer	S1, S2, S4, S7
8. StartTimer	S8
9. PauseTimer	S9
10. ResetTimer	S10
11. StartStopwatch	S11
12. PauseStopwatch	S12
13. ResetStopwatch	S13
14. GetListedAlarm	(Hidden)
15. SetAlarm	S1, S2, S3, S4, S14
16. EnableAlarm	S15
17. DisableAlarm	S16
18. ModifyAlarm	S1, S2, S3, S4, S14
19. DeleteAlarm	S17
20. GetListedWorldTime	(Hidden)
21. ChangeMode	S18
22. SelectMode	S1, S19, S20, S21
23. Display	(Hidden)
24. Beep	(Hidden)
25. MuteBeep	S22

SID	Operation in Sequence Diagram	M-Link
S1	enterSettingMode()	M1, M30, M51, M53, M23, M61, M35, M57, M44
S2	increaseValue()	M2, M24, M36
S3	decreaseValue()	M3, M25, M37
S4	movePointer()	M4, M26, M33, M38
S5	saveSchedule()	M5, M27, M28, M62
S6	deleteSchedule()	M6, M29, M63
S7	saveTime()	M7, M34, M52, M54
S8	startTimer()	M8, M30, M53, M32
S9	pauseTimer()	M9, M34, M54
S10	resetTimer()	M10, M34, M54
S11	startStopwatch()	M11, M30, M55, M31
S12	pauseStopwatch()	M12, M34, M56
S13	resetStopwatch()	M13, M34, M56
S14	saveAlarm()	M14, M39, M58
S15	enableAlarm()	M15, M40, M60
S16	disableAlarm()	M16, M41, M60
S17	deleteAlarm()	M17, M42, M59
S18	changeMode()	M18, M43
S19	moveListPointer()	M19
S20	selectMode()	M20, M45
S21	saveMode()	M21, M46, M47
S22	muteBeep()	M22, M48, M65

MID	Method	Class
M1	enterSettingMode(int mode, int index): void	DWS System
M2	increaseValue(in int object_type, in int pointer): void	
M3	decreaseValue(in int object_type, in int pointer): void	
M4	movePointer(in int object_type): void	
M5	saveSchedule(in int index): void	
M6	deleteSchedule(in int index): void	
M7	saveTime(in int time_type): void	
M8	startTimer(): void	
M9	pauseTimer(): void	
M10	resetTimer(): void	
M11	startStopwatch(): void	
M12	pauseStopwatch(): void	
M13	resetStopwatch(): void	
M14	saveAlarm(int index): void	
M15	enableAlarm(in int index): void	
M16	disableAlarm(in int index): void	
M17	deleteAlarm(in int index): void	
M18	changeMode(): void	
M19	moveListPointer(): void	
M20	selectMode(): void	
M21	saveMode(): void	
M22	muteBeep(): void	

M23	loadSchedule(in int index): Schedule	Mode Controller
M24	increaseScheduleValue(in int index, in int pointer): void	
M25	decreaseScheduleValue(in int index, in int pointer): void	
M26	moveSchedulePointer(in int index): int	
M27	checkScheduleValue(): boolean	
M28	saveScheduleValue(in Schedule curSchedule, in int index): Schedule	
M29	deleteScheduleValue(in int index): boolean	
M30	loadTime(in int time_type): Time	
M31	increaseTimeValue(in int time_type, in int pointer): void	
M32	decreaseTimeValue(in int time_type, in int pointer): void	
M33	moveTimePointer(in int time_type): int	
M34	saveTimeValue(in Time time, in int index, in int time_type): Time	
M35	loadAlarm(in int index): Alarm	
M36	increaseAlarmValue(in int index, in int pointer): void	
M37	decreaseAlarmValue(in int index, in int pointer): void	
M38	moveAlarmPointer(in int index): int	
M39	saveAlarmValue(in Alarm curAlarm, in int index): Alarm	
M40	enableAlarmValue(in int index): void	
M41	disableAlarmValue(in int index): void	
M42	deleteAlarmValue(in int index): boolean	
M43	changeModeValue(): int	
M44	loadSelectedMode(): int[4]	
M45	selectModeValue(in int mode): void	
M46	checkModeValue(): boolean	
M47	saveModeValue(in int mode[4]): void	
M48	muteBeepValue(): void	
M49	calculateSchedule(): Schedule	
M50	checkBeep(): void	

M51	getValue(int index): Time	TimeKeepingMode
M52	saveValue(int index, Time time): Time	
M53	getValue(int index): Time	TimerMode
M54	saveValue(int index, Time time): Time	
M55	getValue(int index): Time	StopwatchMode
M56	saveValue(int index, Time time): Time	
M57	getValue(in int index): Alarm	AlarmMode
M58	saveValue(in int index, in Alarm alarm): Alarm	
M59	deleteValue(in int index): boolean	
M60	toggleAlarm(in int index, in boolean toggle): boolean	ScheduleMode
M61	getValue(in int index): Schedule	
M62	saveValue(in int index, in Schedule schedule): Schedule	
M63	deleteValue(in int index): boolean	WorldTimeMode
M64	getValue(): ArrayList<WorldTime>	
M65	muteTopBeep(): boolean	Beep
M66	beepPopup(): void	